

FEATURES

1. Ultra-small 0.35-mm pitch contributes to downsizing of equipment.

Socket compared to P4S already on the market: 11%

Header: Space-saving of 12% (Comparison using a 20-pin connector)

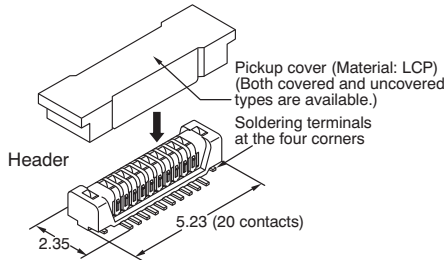
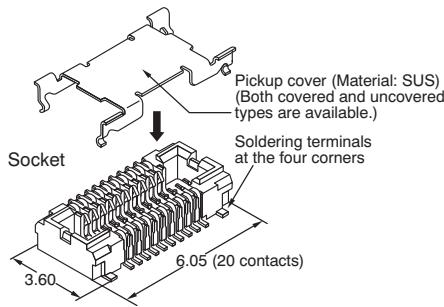

2. Strong resistance to adverse environments! Utilizes "TOUGH CONTACT" construction for high contact reliability.

Note: If extra resistance to drop impact is required, we recommend using our P4 series.

3. Greater flexibility in connector placement.

Pattern wiring to the connector bottom is possible because the undersurface of the connector is constructed with a molded covering.

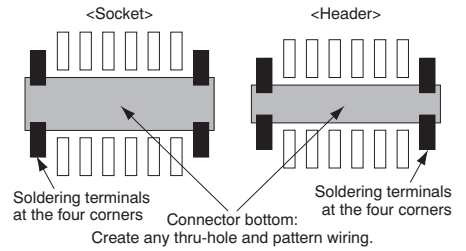

4. Automatic mounting inspection is facilitated by the gull-wing terminal shape which makes mounting verification easy.

5. Connectors for inspection available
Connectors are available that are ideal for inspection in module unit inspection and device assembly processes.

APPLICATIONS

Compact portable devices "Cellular phones, DVC, Digital cameras, etc"

Ideal for Board-to-FPC connections

The simple lock mechanism ensures that the connector clicks into position when it is inserted for reliable single-action insertion on the PCB.

This enables the number of pins to be doubled while the size remains the same as that for existing FPC connectors. This, in turn, contributes to making products and equipment more compact.

ORDERING INFORMATION

AXT **1** **4**

1: Narrow Pitch Connector P35S (0.35 mm pitch) Socket
2: Narrow Pitch Connector P35S (0.35 mm pitch) Header

Number of contacts (2 digits)

Mated height

<Socket>/<Header>

1: For mated height 1.5 mm

Functions

<Socket>/<Header>

2: No pickup cover, without positioning bosses

6: With pickup cover, without positioning bosses

Surface treatment (Contact portion / Terminal portion)

<Socket>

4: Ni plating on base, Au plating on surface (for Ni barrier available)

<Header>

4: Ni plating on base, Au plating on surface

PRODUCT TYPES 

Mated height	Number of contacts	Part number		Packing	
		Socket	Header	Inner carton	Outer carton
1.5mm	20	AXT120124	AXT220124	3,000 pieces	6,000 pieces
	22	AXT122124	AXT222124		
	24	AXT124124	AXT224124		
	26	AXT126124	AXT226124		
	28	AXT128124	AXT228124		
	30	AXT130124	AXT230124		
	32	AXT132124	AXT232124		
	34	AXT134124	AXT234124		
	36	AXT136124	AXT236124		
	38	AXT138124	AXT238124		
	40	AXT140124	AXT240124		
	50	AXT150124	AXT250124		
	52	AXT152124	AXT252124		
	60	AXT160124	AXT260124		
	70	AXT170124	AXT270124		
	80	AXT180124	AXT280124		
90	AXT190124	AXT290124			
100	AXT100124	AXT200124			

- Notes: 1. Regarding ordering units; During production: Please make orders in 1-reel units.
 Samples for mounting confirmation: Available in units of 50 pieces. Please consult us.
 Samples: Small lot orders are possible. Please consult us.
 2. If you require the pickup cover, change the eighth digit of the part number from "2" to "6" in your order. Note that the pickup cover is not available for some types depending on the number of contacts. Check the latest product specifications.
 3. The above part numbers are for connectors without positioning bosses, which are standard. When ordering connectors with positioning bosses, please contact our sales office.
 4. Connectors of different number of contacts are available on-demand production only. Please contact us for more details.

SPECIFICATIONS

1. Characteristics

Item	Specifications	Conditions	
Electrical characteristics	Rated current	0.25A/contact (Max. 4 A at total contacts)	
	Rated voltage	60V AC/DC	
	Breakdown voltage	150V AC for 1 min.	Rated voltage is applied for one minute and check for short circuit or damage with a detection current of 1mA.
	Insulation resistance	Min. 1,000MΩ (initial)	Using 250V DC megger (applied for 1 min.)
	Contact resistance	Max. 100mΩ	Based on the contact resistance measurement method specified by JIS C 5402.
Environmental characteristics	Ambient temperature	-55°C to +85°C	No freezing at low temperatures
	Soldering heat resistance	Max. peak temperature of 260°C (on the surface of the PC board around the connector terminals)	Infrared reflow soldering
		300°C within 5 sec. or 350°C within 3 sec.	Soldering iron
	Storage temperature	-55°C to +85°C (product only) -40°C to +50°C (emboss packing)	No freezing at low temperatures
	Thermal shock resistance (header and socket mated)	5 cycles, insulation resistance min. 100MΩ, contact resistance max. 100mΩ	Sequence 1. -55 [±] 3°C, 30 minutes 2. ~, Max. 5 minutes 3. 85 [±] 3°C, 30 minutes 4. ~, Max. 5 minutes
	Humidity resistance (header and socket mated)	120 hours, insulation resistance min. 100MΩ, contact resistance max. 100mΩ	Temperature 40±2°C, humidity 90 to 95% R.H.
	Saltwater spray resistance (header and socket mated)	24 hours, insulation resistance min. 100MΩ, contact resistance max. 100mΩ	Temperature 35±2°C, saltwater concentration 5±1%
H ₂ S resistance (header and socket mated)	48 hours, contact resistance max. 100mΩ	Temperature 40±2°C, gas concentration 3±1 ppm, humidity 75 to 80% R.H.	
Lifetime characteristics	Insertion and removal life	50 times Repeated insertion and removal speed of max. 200 times/hours	
Unit weight	20-contact type: Socket: 0.03 g Header: 0.02 g		

2. Material and surface treatment

Part name	Material	Surface treatment
Molded portion	LCP resin (UL94V-0)	—
Contact and Post	Copper alloy	Contact portion: Ni plating on base, Au plating on surface Terminal portion: Ni plating on base, Au plating on surface (Except for front edge of terminal) However, the area adjacent to the socket terminal is exposed to Ni on base. Soldering terminals portion; Socket: Ni plating on base, Pd + Au flash plating on surface (Expect for front edge of terminal) Header: Ni plating on base, Au plating on surface (Expect for front edge of terminal)

AXT1, 2

DIMENSIONS

Interested in CAD data? You can obtain CAD data for all products with a **CAD Data** mark from your local Panasonic Electric Works representative.

(Unit: mm)

1. Socket (Mated height: 1.5mm)

- Without pickup cover

CAD Data

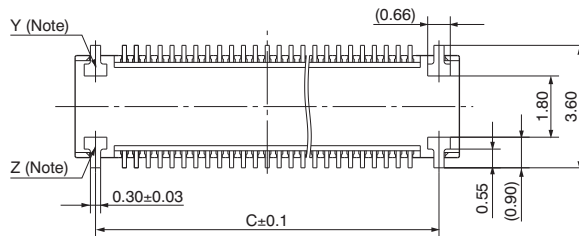
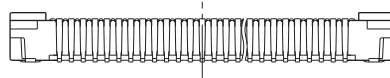
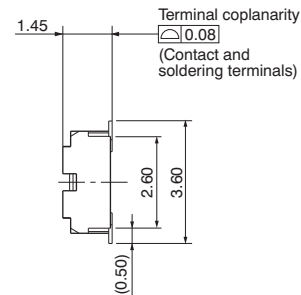
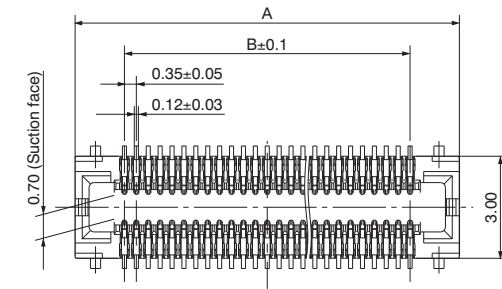

General tolerance: ± 0.2

Dimension table (mm)

Number of contacts/ dimension	A	B	C
20	6.05	3.15	4.85
22	6.40	3.50	5.20
24	6.75	3.85	5.55
26	7.10	4.20	5.90
28	7.45	4.55	6.25
30	7.80	4.90	6.60
32	8.15	5.25	6.95
34	8.50	5.60	7.30
36	8.85	5.95	7.65
38	9.20	6.30	8.00
40	9.55	6.65	8.35
50	11.30	8.40	10.10
52	11.65	8.75	10.45
60	13.05	10.15	11.85
70	14.80	11.90	13.60
80	16.55	13.65	15.35
90	18.30	15.40	17.10
100	20.05	17.15	18.85

- With pickup cover

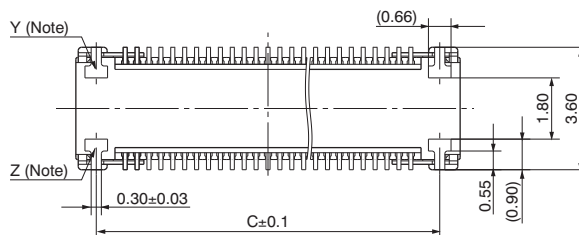
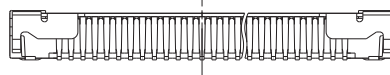
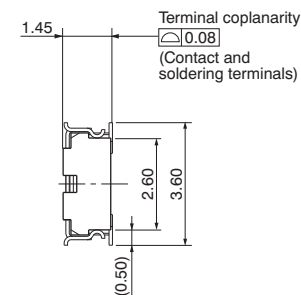
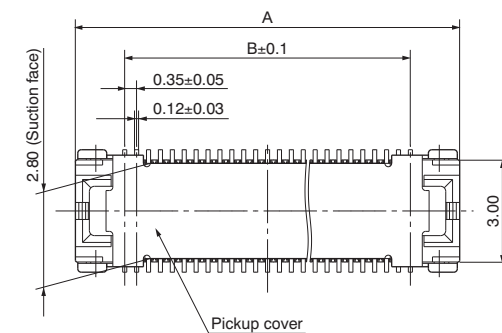

General tolerance: ± 0.2

Note: Since soldering terminals are built into the body, the Y and Z parts are connected electrically.

2. Header (Mated height: 1.5mm)

- Without pickup cover

CAD Data

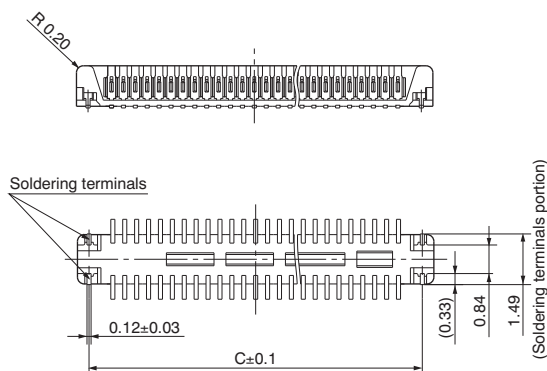
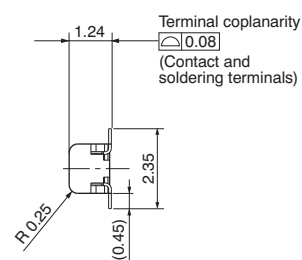
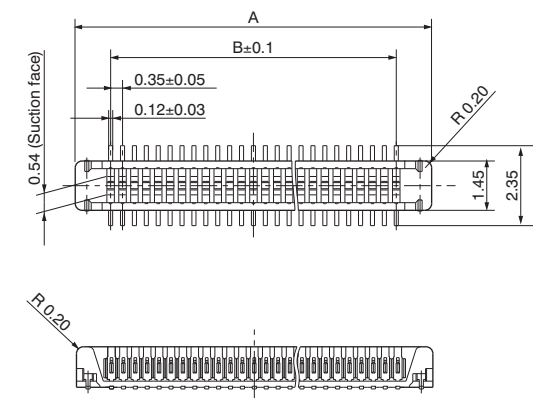

General tolerance: ±0.2

Dimension table (mm)

Number of contacts/ dimension	A	B	C	C
20	5.23	3.15	4.55	6.73
22	5.58	3.50	4.90	7.08
24	5.93	3.85	5.25	7.43
26	6.28	4.20	5.60	7.78
28	6.63	4.55	5.95	8.13
30	6.98	4.90	6.30	8.48
32	7.33	5.25	6.65	8.83
34	7.68	5.60	7.00	9.18
36	8.03	5.95	7.35	9.53
38	8.38	6.30	7.70	9.88
40	8.73	6.65	8.05	10.23
50	10.48	8.40	9.80	11.98
52	10.83	8.75	10.15	—
60	12.23	10.15	11.55	13.73
70	13.98	11.90	13.30	15.48
80	15.73	13.65	15.05	17.23
90	17.48	15.40	16.80	19.98
100	19.23	17.15	18.55	20.73

- With pickup cover

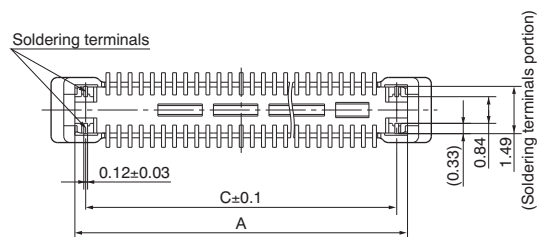
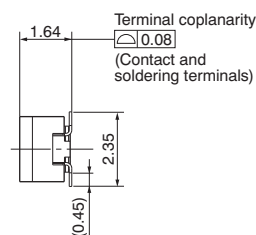
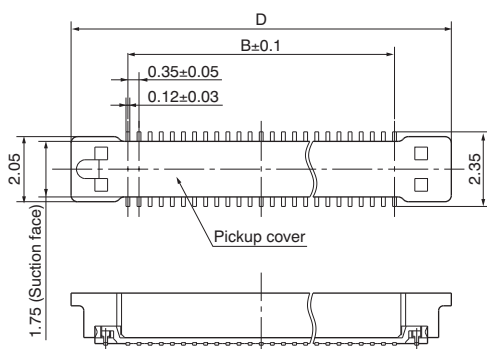

General tolerance: ±0.2

AXT1, 2

Socket and Header are mated

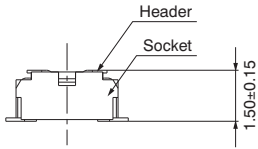

EMBOSED TAPE DIMENSIONS (unit: mm, Common for respective contact type, socket and header)

• Tape dimensions (Conforming to JIS C 0806-1990.

• Plastic reel dimensions (Conforming to EIAJ ET-7200B)

However, some tapes have mounting hole pitches that do not comply with the standard.)

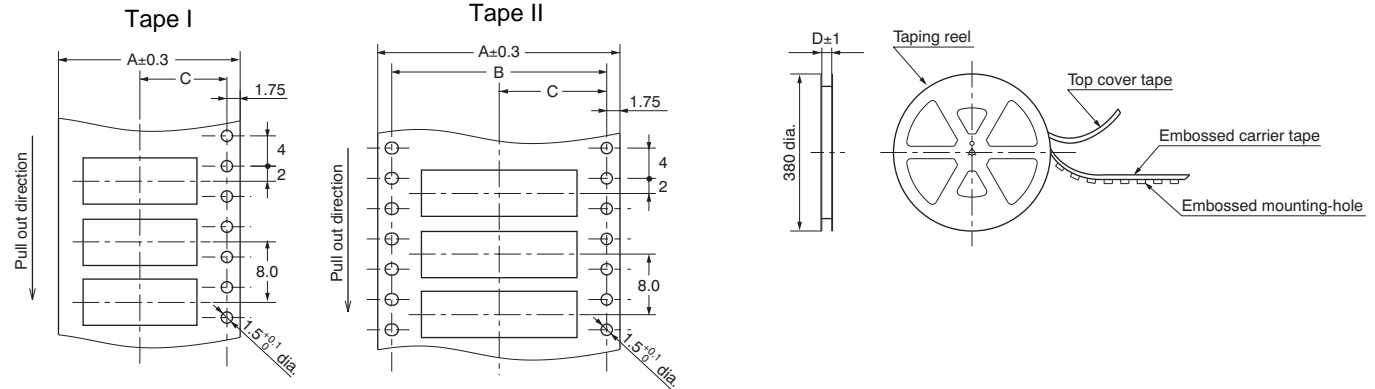

Dimension table (mm)

Mated height	Number of contacts	Type of taping	A	B	C	D	Quantity per reel
Common for socket and header: 1.5mm	Max. 24	Tape I	16.0	—	7.5	17.4	3,000
	26 to 70	Tape I	24.0	—	11.5	25.4	3,000
	72 to 100	Tape II	32.0	28.4	14.2	33.4	3,000

Connector orientation with respect to direction of progress of embossed tape

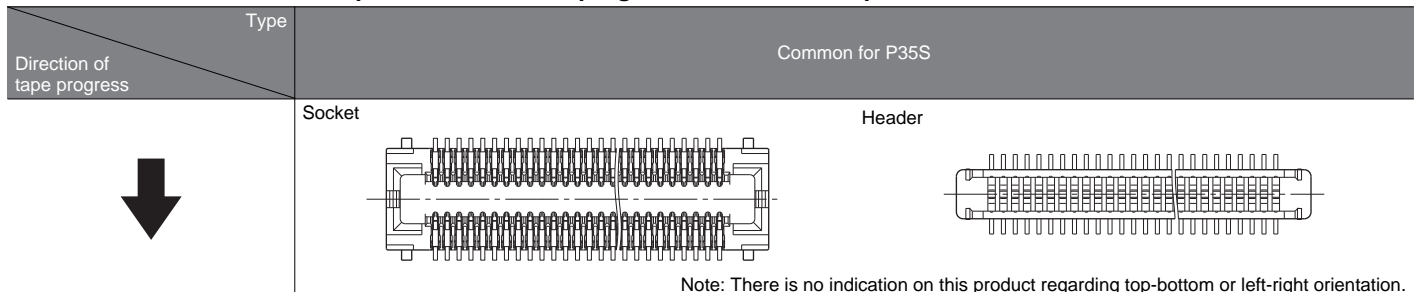

Note: There is no indication on this product regarding top-bottom or left-right orientation.

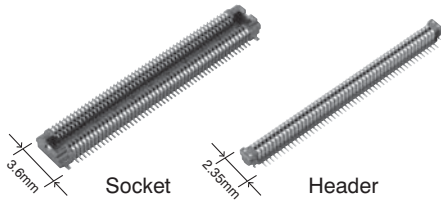

FEATURES

1. 3,000 insertion and removals (when as recommended)
2. Same external dimensions and foot pattern as standard type.
3. Improved mating

Insertion and removal have become easier due to a reduction in the mating retention force required by the simple locking structure and also in the amount of force needed for insertion and removal. (We cannot warrant anything regarding mating retention.)

APPLICATIONS

Ideal for module unit inspection and equipment assembly inspection

TABLE OF PRODUCT TYPES

☆: Available for sale

Product name	Number of contacts																	
	20	22	24	26	28	30	32	34	36	38	40	50	52	60	70	80	90	100
P35S for inspection	☆	☆	☆	☆	☆	☆	☆	☆	☆	☆	☆	☆	☆	☆	☆	☆	☆	☆

- Notes: 1. The pickup surface shape of the inspection sockets is different from that of the standard sockets. (For details, refer to the product specification diagram.)
 2. Please inquire numbers of contacts other than those listed above.
 3. Please inquire us regarding delivery times.
 4. Please keep ordering unit no less than 50 pieces per lot.
 5. Please inquire for further information.

PRODUCT TYPES

Socket	Specifications		Part No.	Header	Specifications		Part No.
	With pickup cover	Without positioning bosses	AXT1E**66		With pickup cover	Without positioning bosses	AXT2E**66
No pickup cover	Without positioning bosses	AXT1E**26	No pickup cover	Without positioning bosses	AXT2E**26		

- Notes: 1. When placing an order, substitute the "*" (asterisk) in the above part number with the number of contacts for the required connector.
 2. The above part numbers are for connectors without positioning bosses, which are standard. When ordering connectors with positioning bosses, please contact our sales office.

AXT1, 2

NOTES

1. As shown below, excess force during insertion may result in damage to the connector or removal of the solder. Please be careful. Also, to prevent connector damage please confirm the correct position before mating connectors.

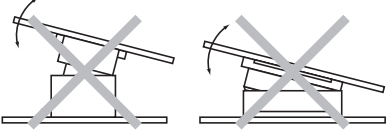

2. Keep the PC board warp no more than 0.03 mm in relation to the overall length of the connector

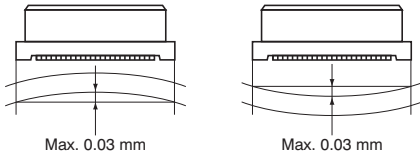

3. If extra resistance to shock caused by dropping is required, we recommend using our previous P4 Series.

4. PC Boards and Recommended Metal Mask Patterns

Connectors are mounted with high density, with a pitch interval of 0.35 mm, 0.4 mm or 0.5 mm.

In order to reduce solder bridge and other issues make sure the proper levels of solder are used.

The figures to the right are recommended metal mask patterns. Please use them as a reference.

Socket (Mated height: 1.5mm)

Recommended PC board pattern
(TOP VIEW)

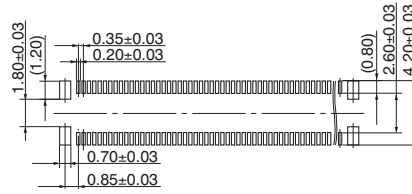

Recommended metal mask pattern

Metal mask thickness: Here, 120 μm
(Terminal portion opening area ratio: 60%)
(Metal portion opening area ratio: 100%)

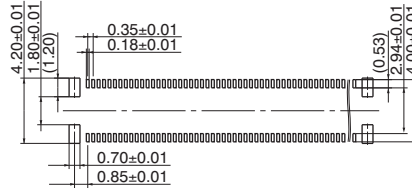

Header (Mated height: 1.5mm)

Recommended PC board pattern
(TOP VIEW)

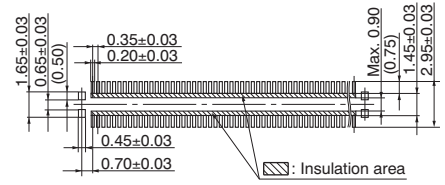

Recommended metal mask pattern

Metal mask thickness: Here, 120 μm
(Terminal portion opening area ratio: 60%)
(Metal portion opening area ratio: 100%)

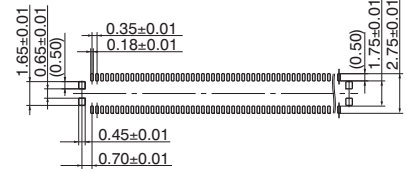

For Cautions for Use, see [Connector Technical Information](#). For other details, please verify with the product specification sheets.